



Alfa Romeo.....	12-16.....	286-291
Alpine.....	17.....	291
Audi.....	17-30.....	291-310
Auto Union.....	30.....	
Autobianchi.....	31.....	310
Bedford.....	31.....	310
BMW.....	31-39.....	310-319
Chevrolet.....	39-40.....	320
Chrysler.....	40.....	320
Citroën.....	40-53.....	320-339
Dacia.....		339
Daewoo.....	53-54.....	339-340
Daihatsu.....	54-56.....	340-342
Fiat.....	56-70.....	342-358
Ford.....	70-89.....	358-381
Honda.....	89-94.....	381-385
Hyundai.....	94-97.....	386-387
Innocenti.....	97.....	387
Isuzu.....	97-98.....	388
Jaguar.....	98-99.....	388-389
Jeep.....	99.....	390
Kia.....	99-101.....	390-391
Lada.....	101-102.....	391
Lancia.....	102-106.....	392-396
Land Rover.....	107.....	397
LDV.....	107.....	
Lexus.....	107.....	397
Mazda.....	107-114.....	397-403
Mercedes.....	114-133.....	404-427
Mini.....	133.....	427
Mitsubishi.....	133-142.....	427-435
Moskvich.....	142.....	
Nissan.....	142-150.....	435-444
Opel.....	151-169.....	444-469
Peugeot.....	169-184.....	469-490
Pininfarina.....	184.....	490
Porsche.....	184-186.....	490-491
Proton.....	186.....	491
Renault.....	186-201.....	492-509
Rolls-Royce.....		509
Rover Group.....	201-206.....	509-514
Saab.....	206-209.....	514-518
Seat.....	209-215.....	518-527
Skoda.....	215-219.....	527-532
Smart.....	219-220.....	532
Ssang Yong.....	220.....	532-533
Subaru.....	220-224.....	533-535
Suzuki.....	224-226.....	535-537
Talbot.....	226-227.....	537-538
Toyota.....	227-238.....	538-549
Trabant.....	238.....	
Triumph.....	239.....	549
Vauxhall.....	239-250.....	549-567
Volkswagen.....	250-276.....	567-606
Volvo.....	276-285.....	606-617
Wartburg.....	285.....	

**(D) Starter 12-285**

**(GB) Starter motors**

**(F) Démarreurs**

**(I) Motorini d'avviamento**

**(NL) Startmotors**

**(D) Generator 286-617**

**(GB) Alternators**

**(F) Alternateur**

**(I) Alternatori**

**(NL) Alternators**

**(D) Produkt-information 618-866**

**(GB) Product information**

**(F) Information des produits**

**(I) Informazione del prodotto**

**(NL) Produkt informatie**

**(D) Vergleichsliste 867-984**

**(GB) Part no interchange**

**(F) Liste correspondances**

**(I) Indice comparativo**

**(NL) Vergelijgingslijst**



Wo befinden sich die Herstellernummern? Where you can find the manufacturer number?  
 Oú trouver la référence origine? Dove si trova il numero di comparazione?  
 Waar staan de fabrikant referenties ?

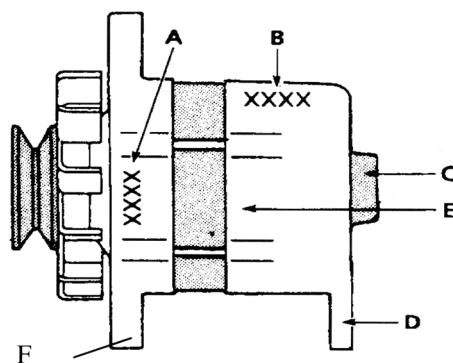
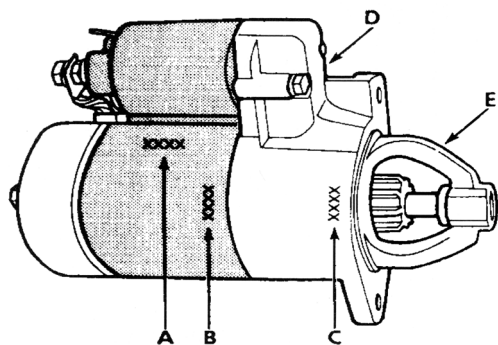

Hersteller  
 Manufacturer  
 Constructeur  
 Produttore  
 Fabrikant

Position  
 Posición  
 Posizione  
 Positie

Hersteller  
 Manufacturer  
 Constructeur  
 Produttore  
 Fabrikant

Position  
 Posición  
 Posizione  
 Positie

Bosch . . . . .	B
Delco Remy . . . . .	B
Ducellier . . . . .	B
Femsa . . . . .	B
Friesen . . . . .	B
Hitachi . . . . .	C
Iskra . . . . .	B
Lucas . . . . .	B
Magneti Marelli . . . . .	D, E
Mitsubishi . . . . .	C, D
Nippondenso . . . . .	A
Pal Magnetron . . . . .	B
Paris Rhone . . . . .	B
Valeo . . . . .	B

Bosch . . . . .	E
Delco Remy . . . . .	A
Ducellier . . . . .	C
Femsa . . . . .	C, D, E
Friesen . . . . .	A, F
Hitachi . . . . .	A
Iskra . . . . .	E
Lucas . . . . .	B, C
Magneti Marelli . . . . .	B, C
Mitsubishi . . . . .	B, C
Motorola . . . . .	B, C
Nippondenso . . . . .	B
Pal Magnetron . . . . .	B
Paris Rhone . . . . .	B, C
SEV . . . . .	B, C
Valeo . . . . .	C, E

**Generatorklemmenbezeichnung / Alternator Terminal Designations / Désignation de borne de Alternateur/ Definizione morsetti dello alternatori / Verklaring Alternators aansluiting**

<b>W</b>	Drehzahlmesser / Rev-Counter / Compte-tours / Contagiri / Toerentalmeter										
<b>DF / DFM</b>	Multifunktionsanschluß / Multiple function connection / Connecteur multifonctions / Collegamento multi funzione / Universele aansluiting										
	Lucas	Bosch	Delco Remy	Ducellier	Fiat	Hitachi	Marelli	Mitsubishi	Nippon Denso	Paris Rhône	Motorola Marchal
<b>Feld Field Champ Zona Veld</b>	F	DF	Bat	Exc	67	F	67	F	F	Exc	DF/Exc
<b>Batterie + Battery + Attacco batteria + Accu +</b>	B+	B+	+	+	30	B	30	B	B	B+	B+
<b>Masse Earth Masa Massa</b>	-	D-	GRD	B-	31	E	31	E	E-	B-	B-
<b>Kontrolllampe Control lamp Témoin d'alerte Lampada spia Controle lamp</b>	IND / +	D+ / 61	+	Ind	15	L*	15	L*	L*	L*	D+ / 61
<p>* : Lampe arbeitet über Relais          : Lamp switched by relay          : Lampe commandée par relais          : La spia funziona tramite il relè          : Lamp werkt over het relais</p>											

**Starterklemmenbezeichnung / Starter Motor Terminal Designations / Désignation de borne de démarreur / Definizione morsetti dello starter / Verklaring Startmotor aansluiting**

<b>15</b>	Plus Geschaltet / Switched positive output from battery/ Raccordés au pôle positif de batterie / Connessione positiva / Aangesloten aan positieve pool van de batterij
<b>15a</b>	Ausgang zum Vorschaltwiderstand (Kaltstart oder Zündung) / Output to ballast resistor (Cold Start or IGN) / Sortie vers le résistance (préchauffage ou l'allumage) / Uscita per il resistore addizionale (avviamento a freddo o accensione) / Uitgang naar de ballast weerstand ( voorverwarming of ontsteking)
<b>30</b>	Dauerplus Batterie / Input direct from battery positive / Entrée directement du positif de batterie / Batteria lunga durata / Input direct van positieve batterij pool
<b>30h/45/45a</b>	Eingang zum Feld/Anker oder Ausgang Starter Relais / Input to field/armature or Output to starting relay / Entrée au champ/armature ou sorti au relais de démarrage / Ingresso per campo/ancoretta o uscita per il relè dello starter / Ingang aan veld/anker of uitgang naar start relais
<b>50</b>	Kontrolllampe Starter / Starter motor control (energises the solenoid) / Activering motor management (activeert de solenoïde) / Spia di controllo dello starter / L'activation moteur management (active le solénoïde)

**Generatorenfreiläufe / Free wheel pulley / Poulie roue libre /  
Dispositivo ruota libera / Generator vrijloop**

**1010034**



17x61x37,7

**Mercedes**

140 Series	S300TD
202 Series	C200D, C220D, C200TD, C220TD
210 Series	E200D, E220D, E250D, E290TD, E300D, E300TD
463 Series	G300TD
901, 902 Series	208D, 210D
903 Series	308D
904 Series	408D

**1010038**



17x61x35

**Volkswagen**

Passat (3B) 2.3 V5, 2.3 VR5

**1010045**



17x61x36,5

**Audi**

A4 (8D)	1.9TDI
A6 (4B)	1.9TDI
Passat (3B)	1.9TDI

**Volkswagen**

**1010047**



17x55x40,5

**Mercedes**

202 Series	C200CDI, C220CDI, C200T CDI, C220T CDI
Vito (638)	108CDI, 110CDI
V-Klasse (638/2)	V200CDI, V220CDI

**1010048**



17x61x37,2

**Seat  
Volkswagen**

Arosa (6H)	1.7SDI
Polo (6N)	1.7SDI, 1.9D, 1.9SDI

**Generatorenfreiläufe / Free wheel pulley / Poulie roue libre /  
Dispositivo ruota libera / Generator vrijloop**

**1010053**



17x61x33,5

**Mercedes**

Vito (638) 108 D 2.3  
V-Klasse (638/2) V230TD

**1010061**



17x61x42,45

**Audi**

A2 (8Z) 1.4TDI  
A3 (8L) 1.6, 1.8, 1.9TDI  
A3 (8P) 1.6, 1.9TDI, 2.0FSI, 2.0TDI, 3.2 V6  
A4 (8E) 1.9TDI  
TT (8N) 1.8T

**Ford  
Seat**

Galaxy (WGR) 1.9TDI  
Alhambra (7V) 1.8T, 1.9TDI, 2.0i, 2.8 V6  
Arosa (6H) 1.4TDI  
Cordoba (6K) 1.9SDI, 1.9TDI  
Cordoba (6L) 1.4TDI, 1.9SDI, 1.9TDI  
Ibiza II (6K) 1.9TDI, 1.9SDI  
Ibiza IV (6L) 1.4TDI, 1.9SDI, 1.9TDI  
Inca (6K) 1.9SDI, 1.9TDI  
Leon (1M) 1.6, 1.8, 1.9SDI, 1.9TDI  
Toledo II (1M) 1.6, 1.8, 1.9TDI, 2.3 V5

**Skoda**

Fabia (6Y) 1.9SDI, 1.9TDI  
Octavia (1U) 1.6, 1.8, 1.9SDI, 1.9TDI  
Bora (1J) 1.6, 1.8, 1.9SDI, 1.9TDI  
Golf IV (1J) 1.8, 1.9TDI, 2.3 V5

**1010062**



17x61x35

**Audi**

A4 (8D) 1.6, 1.8, 1.9TDI  
A6 (4A, 4B) 1.9TDI  
Cabriolet (8G) 1.9TDI

**Ford  
Seat**

Galaxy (WGR) 1.9TDI  
Ibiza II (6K) 1.9TDI  
Toledo I (1L) 1.9TDI

**Skoda  
Volkswagen**

Superb (3U) 1.8T, 1.9TDI  
Passat (3B) 1.6, 1.8T, 1.9TDI  
Polo (6K) 1.9TDI

**1010067**



17x61x42,45

**Audi  
Seat  
Skoda  
Volkswagen**

A3 (8L) 1.9TDI  
Alhambra (7V) 1.8T  
Octavia (1U) 1.9SDI, 1.9TDI  
Golf IV (1J) 1.9SDI, 1.9TDI  
Sharan (7M) 1.8T

**Generatorenfreiläufe / Free wheel pulley / Poulie roue libre /  
Dispositivo ruota libera / Generator vrijloop**

**1010073**



17x55x40,65

<b>Seat</b>	Alhambra (7V)	1.9TDI, 2.0i
	Cordoba (6K)	1.9SDI, 1.9TDI
<b>Volkswagen</b>	Ibiza II (6K)	1.9SDI, 1.9TDI
	Inca (6K)	1.7D, 1.9SDI
	Toledo I (1L)	1.9TDI
	Caddy II (9K)	1.9SDI, 1.9TDI
	Golf III (1K)	1.9D, 1.9TD, 1.9TDI
	Golf IV (1E)	1.9TDI
	Passat (3A)	1.6, 1.8, 1.9TD, 1.9TDI, 2.0
	Polo (6K)	1.7SDI, 1.9TDI
	Sharan (7M)	1.9TDI, 2.0
	Vento (1H)	1.9D, 1.9TD, 1.9TDI

**1010074**



17x61x35

<b>Audi</b>	A6 (4B)	1.8, 1.8T
-------------	---------	-----------

**1010079**



17x61x36,53

<b>Volkswagen</b>	Passat (3B)	2.3 VR5
-------------------	-------------	---------

**1010080**



17x64x40,6

<b>Nissan</b>	Patrol (Y61)	3.0DTI
	Terrano II (R20)	3.0DI

**1010081**



17x55,4x36,6

<b>Mercedes</b>	203 Series	C200CDI, C220CDI, C270CDI
	210 Series	E200CDI, E220CDI, E270CDI, E320CDI

**Generatorenfreiläufe / Free wheel pulley / Poulie roue libre /  
Dispositivo ruota libera / Generator vrijloop**

**1010082**



17x54,65x35,25

<b>Citroën</b>	C5	2.0HDI, 2.2HDI
	C8	2.0HDI, 2.2HDI
<b>Fiat</b>	Jumper (244)	2.0HDI, 2.2HDI
	Xantia (X2)	2.0HDI
<b>Peugeot</b>	Xsara (N1)	2.0HDI
	Ducato (230)	2.0JTD
	206 (2A/C)	2.0HDI
	307 (3A/C)	2.0HDI
	406 (8B)	2.0HDI, 2.2HDI
	806 (221)	2.0HDI
	807 (E)	2.0HDI, 2.2HDI
	Boxer (244)	2.0HDI, 2.2HDI
	Expert (224)	2.0HDI

**1010083**



17x53,3x38,8

<b>Mitsubishi</b>	Space Star (DG0)	1.9DI-D
	Interstar (X70)	DCI80
<b>Nissan</b>	Primastar (X83)	DCI80, DCI100
	Movano (J9/F9)	1.9DTI
<b>Opel</b>	Vivaro (J7/F7)	1.9DTI
	Laguna II (BG0/1)	1.9DCI
<b>Renault</b>	Master II (JD/ND)	1.9DCI
	Traffic II (JL)	1.9DCI

**1010084**



17x61x32,24

<b>Ford</b>	Probe II (ECP)	2.5 V6
	626 IV (GE)	2.5 24V

**1010086**



17x61x32,24

<b>Volvo</b>	C70	2.0, 2.0T, 2.3T, 2.5T
	S60	2.0T, 2.4, 2.4T, 2.5T
	S70	2.0, 2.0T, 2.3T, 2.5T
	V70 I	2.0, 2.0T, 2.3T, 2.4, 2.4T, 2.5T

**1010088**



17x55x49,55

<b>Mercedes</b>	A-Klasse (W168)	A160CDI, A170CDI
-----------------	-----------------	------------------

**Generatorenfreiläufe / Free wheel pulley / Poulie roue libre /  
Dispositivo ruota libera / Generator vrijloop**

**1010089**



17x60,15x43,1

<b>Volvo</b>	S40 I (VS)	1.6, 1.8, 1.9 T4, 2.0, 2.0T
	V40 (VW)	1.6, 1.8, 1.9 T4, 2.0, 2.0T

**1010090**



17x65,5x37,4

<b>Alfa Romeo</b>	145 (930)	1.9JTD
	156 (932)	1.9JTD, 2.4JTD
<b>Fiat</b>	Brava, Bravo (182)	1.9JTD
	Marea (185)	1.9JTD
	Punto (188)	1.9JTD
<b>Lancia</b>	Kappa (838A)	2.4JTD
	Lybra (839AX)	1.9JTD

**1010091**



17x61x35

<b>Audi</b>	A4 (8D)	1.6, 1.8
	A6 (4B)	1.8
<b>Skoda</b>	Superb (3U)	2.0
<b>Volkswagen</b>	Passat (3B)	1.6, 1.8, 2.0

**1010092**



17x57x49,55

<b>Mercedes</b>	168 Series	A190, A210
<b>Mercedes</b>	Vaneo (414)	1.9

**1010093**



17x61x37,17

<b>Mercedes</b>	G-Klasse (W461)	G290TD
-----------------	-----------------	--------

**Generatorenfreiläufe / Free wheel pulley / Poulie roue libre /  
Dispositivo ruota libera / Generator vrijloop**

**1010094**



17x58x35

**Porsche**

911 (996)

3.4 Carrera, 3.6 Turbo 4

**1010095**



17x61x41,2

**Mitsubishi  
Renault**

Carisma (DA\_)  
Clio II (BB0/1/2)  
Kangoo (KC0/1)

1.9DI-D,  
1.9DTI  
1.9DCI, 1.9DTI

**1010096**



17x55x40,6

**Mercedes**

220 Series  
463 Series

S400CDI  
G400CDI

**1010097**



17x61x37,2

**Seat  
Volkswagen**

Arosa (6H)  
Lupo (6X/6E)  
Polo (6N)

1.7SDI  
1.7SDI  
1.7SDI, 1.9D, 1.9SDI

**1010101**



17x55x40,5

**Mercedes**

202 Series  
Sprinter (901, 902)  
Sprinter (903)  
Sprinter (904)  
Vito (638)

C200CDI, C220CDI  
208CDI, 211CDI, 213CDI  
308CDI, 311CDI, 313CDI  
408CDI, 411CDI, 413CDI  
108CDI, 110CDI

**Generatorenfreiläufe / Free wheel pulley / Poulie roue libre /  
Dispositivo ruota libera / Generator vrijloop**

**1010103**



17x55x36,5

**Mercedes**

Vario

612D, 812D

**1010111**



17x70x38,3

**Audi**

A8 (4D)

2.8

**1010112**



17x73x41,4

**Volkswagen**

Transporter T4 (70X) 2.5TDI

**KS100**

**Montagewerkzeug / Fitting-Tool / Outil pour poulie /  
Attrezzo di montaggio / Montage gereedschap**



**Montagewerkzeug für Generatorenfreiläufe**  
Passend für Bosch und Valeo Generatoren





**Fitting-Tool for free wheel pulley**  
Suitable for Bosch and Valeo

**Outil pour poulie avec roue libre**  
Adaptable pour Bosch et Valeo



**Attrezzo di montaggio per pulegge**  
Adatto per gli alternatori Bosch e Valeo

**Montage gereedschap voor vrijloop naaf**  
Voor Bosch en Valeo toepassingen

**Ersetzungen / Supersessions / Références Remplacées /  
Riferimenti Sostituite / Vervangen Referenties**

 → 		 → 			
8015490	⇒	8015200	9034640	⇒	9034480
8018190	⇒	8012320	9036810	⇒	9036820
8019930	⇒	8017770	9038260	⇒	9037990
8019980	⇒	8017300	9040990	⇒	9038950
8080053	⇒	8017530	9041040	⇒	9038170
8080201	⇒	8080202	9041530	⇒	9942520
			9041600	⇒	9030840
			9041870	⇒	9042830
			9090184	⇒	9042830
			9933750	⇒	9042830
			9942400	⇒	9042830

**Neuaufnahmen / New to range / Nouveau /  
Nuovi riferimenti / Nieuw**

		
8021230 BMW	9045101 Nissan, Opel, Renault	
8021640 Citroen/Fiat/Peugeot	9046610 Mercedes	
8052182 Nissan	9047910 Citroen, Fiat, Ford	
8080173 Mercedes	Peugeot	
8080174 BMW	9090205 Renault	
8080175 Audi	9090225 Mercedes	
8080177 Opel	9090313 Mercedes	
8080178 Citroen/Peugeot/Renault	9090316 Renault	
8080179 Citroen/Peugeot	9090317 BMW	
8080180 Renault	9090318 Renault	
8080181 Fiat	9090319 Mercedes	
8080182 Fiat	9090320 BMW	
	9090321 Renault	
	9090322 Fiat	
	9090323 Citroen/Fiat/Peugeot	
	9090324 Fiat/Opel	
	9090325 Fiat/Opel	
	9090326 Fiat/Opel	
	9090328 Fiat	
	9090329 Fiat	
	9090330 Citroen/Fiat	
	9090331 Opel/Renault	